

PRODUCT CATALOGUE

STATIONARY AND PORTABLE / COLD AND THERMAL FOGGING DEVICES



Pulsfogging is the generation of ultra-fine droplets in a range of 1-50 µm using cold pneumatic- or thermo-pneumatic energy. Liquid substances are vaporised at the end of fogging barrel and form ultra-fine aerosols by condensing on contact with cool ambient air. Thermal fogging and cold fogging is used for any pest control task where active substances should be uniformly distributed within a large area, even in inaccessible places, without leaving undesirable residues.

Thermal Fogger



pulsFOG K-10-SP, portable
with optional protection guard

Empty weight:	7 kg
Chemical tank:	5 l
Engine performance:	17,5 kW
Flow rate:	10 - 35 l/h

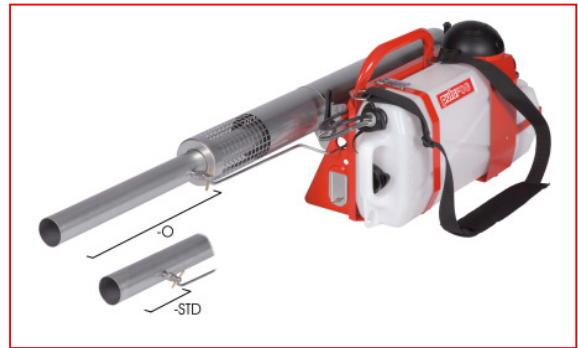

pulsFOG K-10-STD + K-10-O, portable*)
with optional protective grating

Empty weight:	8,5 kg
Chemical tank:	10 l
Engine performance:	17,5 kW
Flow rate:	10 - 35 l/h



pulsFOG K-10-SP-SAN, portable

Empty weight:	7,6 kg
Chemical tank:	5 l
Engine performance:	17,5 kW
Flow rate:	10 - 15 l/h



pulsFOG K-10-DESERT, portable

Empty weight:	8,5 kg
Chemical tank:	6 l
Engine performance:	17,5 kW
Flow rate:	10 - 35 l/h

*) **Standard-units** are designed to fog water-based, non-flammable fogging solutions and suspensions.
O-units are designed to fog inflammable and non-flammable fogging solutions but not suspensions.

AEROSOLSYSTEMS

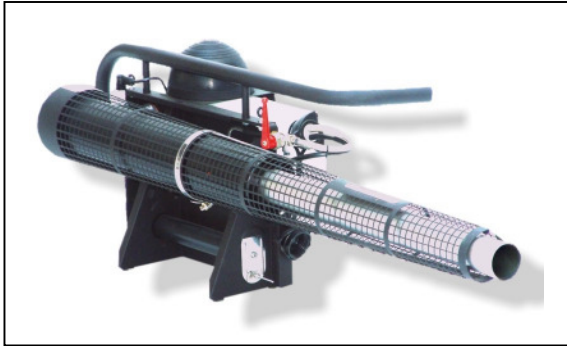

pulsFOG K-10-SP-DECO, portable special version with 3-way-tap and automatic cut-off device for chemical flow
 Empty weight: 9,5 kg
 Chemical tank: 6 l
 Engine performance: 17,5 kW
 Flow rate: 10 - 35 l/h



pulsFOG K-22-STD + K-22-O portable* (pictured K-22-STD)
 Empty weight: 10 kg
 Chemical tank: 10 l
 Engine performance: 37,4 kW
 Flow rate: 20 - 60 l/h



pulsFOG K-22-BIO, portable
 Empty weight: 11,2 kg
 Chemical tank: 2x5 l
 Engine performance: 37,4 kW
 Flow rate: 20 - 60 l/h



pulsFOG K-22-10-O, small tubular frame
 Empty weight: 18 kg
 Chemical tank: 55 l
 Engine performance: 37,4 kW
 Flow rate: 20 - 75 l/h



pulsFOG K-22-10-O, large tubular frame
 Empty weight: 46 kg
 Chemical tank (stainless steel): 80 l
 Engine performance: 37,4 kW
 Flow rate: 20 - 75 l/h



pulsFOG K-22-10-BIO, large tubular frame
 Empty weight: 42 kg
 Chemical tank: 2x55 l
 Engine performance: 37,4 kW
 Flow rate: 20 - 75 l/h

AEROSOLSYSTEMS



pulsFOG K-30-STD + K-30-O portable*)

(pictured K-30 Standard)

Empty weight: 12 kg
 Chemical tank: 10 l
 Engine performance: 75 kW
 Flow rate: 30 - 120 l/h



pulsFOG K-30-20-STD + K-30-20-O

small tubular frame *)

Empty weight: 23 kg
 Chemical tank: 55 l
 Engine performance: 75 kW
 Flow rate: 30 - 120 l/h



pulsFOG K-30-20-BIO, small tubular frame

Empty weight: 22 kg
 Chemical tank: 2x55 l
 Engine performance: 75 kW
 Flow rate: 30 - 190 l/h

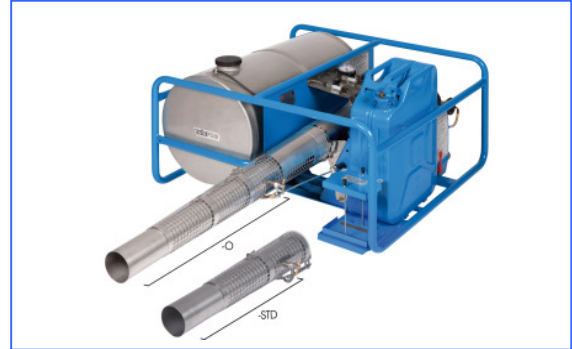

pulsFOG K-30-20-STD + K-30-20-O

large tubular frame *)

Empty weight: 55 kg
 Chemical tank (stainless steel): 80 l
 Engine performance: 75 kW
 Flow rate: 30 - 120 l/h



pulsFOG K-30-20-BIO, large tubular frame

Empty weight: 45 kg
 Chemical tanks: 2x55 l
 Engine performance: 75 kW
 Flow rate: 30 - 190 l/h



pulsFOG K-30-20-BIO, large tubular frame

Empty weight: 62 kg
 Chemical tanks (stainless steel): 2x65 l
 performance: 75 kW
 Flow rate: 30 - 190 l/h

Optional Accessories



Turntable for stationary thermal fogger



Polyethylene tanks
55 l



Automatic cut-off valve as a safety device for the riskless application of inflammable fogging solutions with thermal fogger

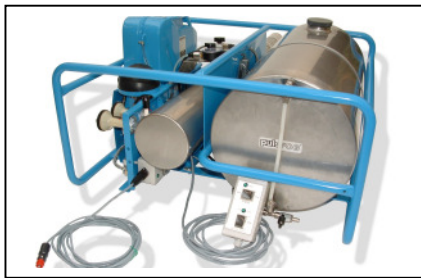

Remote control, 12 V, for thermal fogger mounted on truck

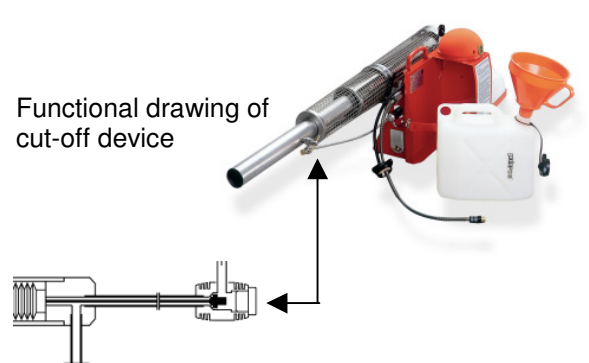

pulsFOG ULV SUPER PRO
made by pulsFOG do Brasil



Type: Ultra low volume (ULV) cold aerosol generator, vehicle mounted.

Engine: 18 HP Briggs&Stratton 4 stroke gasoline V-Twin engine, with electric and manual start, with complete lubrication system, 15 A alternator and combined digital hour-meter and tachometer.

Blower: Roots blower, almost maintenance free
Metering pump with remote control: FMI (USA) mechanically controlled

Fogging nozzle: pulsFOG gaseous energy fogging nozzle, with full horizontal and vertical movement, complies with WHO specifications of construction and performance, allowing a flow rate of max 600 ml/min

Chemical tank capacity: 60 l

Fuel tank: transparent polyethylene, 32 liters

Dimensions: length 95 cm, width 79 cm, height 90 cm

Weight empty: 190 kg

TracFOG

manufactured by pulsFOG do Brazil

Technical data

Empty Weight :	250 kg
Dimensions of main body :	depth 105 x width 78 x heights 170 cm
Solution tank capacity on choice:	400 l and 100 l
Droplet size :	20-30µm
Flow rate :	70 – 100 l/h dependent of nozzle size
Flow adjustment :	restriction nozzles
Blower :	Rotary piston blower (roots type)
Number of Fogging nozzles on choice:	2 special far-throwing nozzles 6 or 12 low distance nozzles
Location of fogging nozzles on choice:	Mounted on 2 movable short arms with remote control (forest treatment) Mounted on 2 movable long arms for greenhouse application Mounted on 2 side barrels for low and high crop plantations with pathways for tractors
Driving gear :	power-take off (P.T.O Standard 35-Z6 resp.)
Powerrequirement:	Min. 15 hp



The nozzle design allows the use of any pesticide formulation including wettable powders

The TracFOG is designed to treat large plantations in- and outdoors using ULV technology. Mounted on tractor with **power take-off**. This fogger uses the energy from the tractor engine. 2 ULV-nozzles are movable to all directions. In no wind conditions a height of 15 m is reached.

World Novelty

Fogger with PTO technic

The TracFOG operates with a droplet spectrum of 20-30µm using oil-based biocide formulations and a volume of 20-80 l/ha dependent to the kind of application. The high performance of this track mounted ULV fogger leads to a application speed of 3-12 ha/h



Electrical Coldfogger



pulsFOG Turbo ULV
 Portable, manufactured in cooperation with pulsFOG do Brazil

Low cost cold fogger, suitable for every pest control task: lightweight, movable and simple to operate.



pulsFOG Turbo ULV, portable	
Weight:	5,5 kg
Dimensions:	30x32x35 cm
tank capacity:	5 l
Power supply:	230 V
Electrical performance:	5,25 A
	1,0 kW
Droplet throwing range:	20 m
Flow rate dependent to nozzle size used:	110 - 330 ml/min

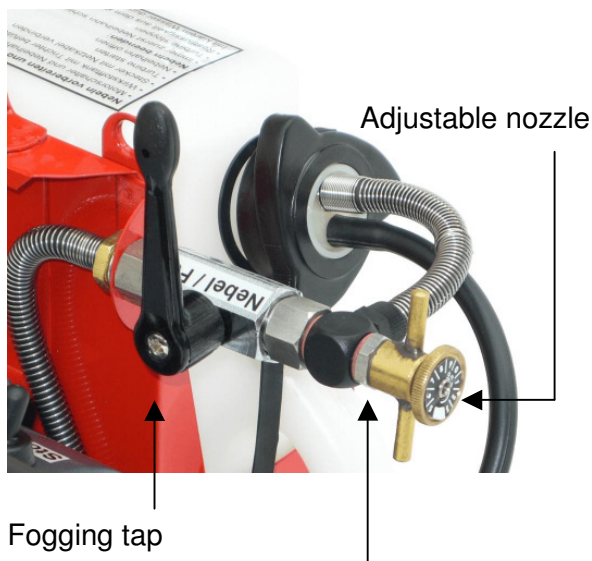

The Turbo **ULV** is equipped with an exchangeable nozzle system to provide a fixed preselected flow rate of spraying formulation. Optionally there is an adjustable nozzle available, which however does not provide a repeatable fixed flow rate.

The chemical tank is easily detachable for filling and cleaning tasks.

pulsFOG rapid Fogger

air humidification and chemical aerosol system

The rapid- Fogger is a pneumatic coldfogging unit for external connection with a compressor. The technical particularity is composed to a self sucking long-range throwing ring-slot nozzle for droplet sizes below 10 µms, precondition for a number of applications. The compact machine can be equipped optionally with all desired automatic functions. Due to the separation of the fogging unit from the compressor it can be operated far away from the source of noise in rooms with sensitive content.

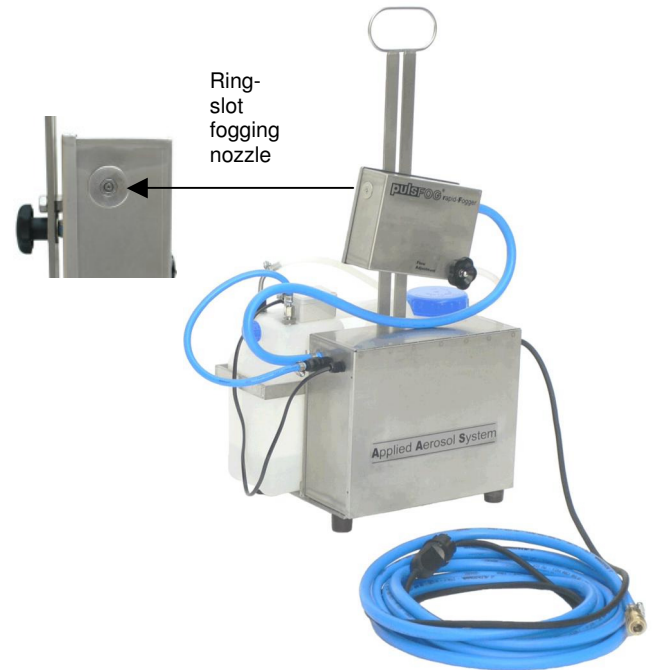

Size (width x length x height):	43,5 x 26 x 67 cm
Empty weight:	~ 10 kg
Chemical tank:	10 litres
Required air pressure (min-max)	3 – 6 bar*
Required speed of compressed air	200-400 ml/s*

*dependent to nozzle size used.



Coldfogger for fast and dry chemical fog application indoor plant protection, disinfection, air humidification, inhalation



Useful Accessories

- 1) pulsFOG light protection suit
- (2) Mixing set, including:
 one 10 l bucket with graduation
 one 2 l graduated measure
 one 250 ml graduated measure
 one pair of chemical resistant rubber gloves
 one wooden stirrer
- (3) 5 l cleaning kit
- (4) Fuel measure
- (5) Large Solution funnel
- (6) Solution funnel,
- (7) Small pulsFOG tool bag
- (8) Cleaning drill for nozzle
- (9) Gas mask with filter A2-B2-P3
- (10) Cleaning rod with brush
- (11) Ear protector
- (12) Spare parts set, small
- (13) Spare parts set, large





Mathias Stahl
Executive Manager



Ingrid Hensler,
Head of sales department



Ingo Weissensteiner,
Head of purchase- and
account department



Elvira Braunwarth
customer support



Jennifer Schulze
customer support

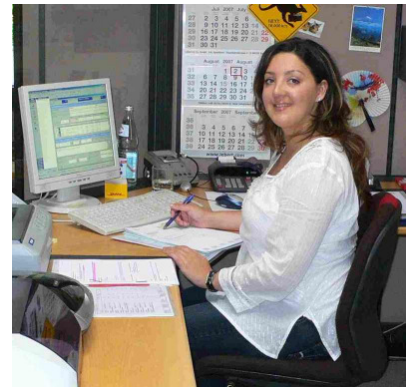

Evelyn Friederichs,
customer support



the staff

pulsFOG production facilities



pulsFOG Factory in 2007



Werner Stahl,
President

Serial production
of large
Thermal Fogger



Serial production of portable thermal

pulsFOG patents are issued, applied for or pending worldwide under the following numbers:

Europe :	EU	0060938,	94112785.4,	0092057,	92 115 438.1,
	GER	P2835338	P3214932.8	P3100414.8	P3521941.6
		P2938958.0	P3230184.7	P3306546.2	
	GB	2028170	2066 367	2125317	
	F	7920407	8020747		
	I	982677	967324		
	CH	660668			
	NL	8004432	149990		
USA:		4.298.167	4.504.214	08/274.267	992 039
Canada:		4.556.383	1.144.227	1.195.229	5.224.651
Japan:		1 223491	133094/80	195755/81	5-245 415
Brazil:		PI7508223	PI7904982	PI8006095	PI8200067



pulsFOG patents are issued, applied for or pending worldwide under the following numbers:

Europe

EU 0060938 // 94112785.4 //
0092057 // 92 115 438.1

GER P2835338 // P3214932.8 //
P3100414.8 // P3521941.6 //
P2938958.0 // P3230184.7 //
P3306546.2

GB 2028170 // 2066 367 // 2125317

F 7920407 // 8020747

I 982677 // 967324

CH 660668

NL 8004432 // 149990

USA+ 4.298.167 // 4.504.214 //
08/274.267 // 992 039

Canada: 4.556.383 // 1.144.227 //
1.195.229 // 5.224.651

Japan: 1 223491 // 133094/80 //
195755/81 // 5-245 415

Brazil: PI7508223 // PI7904982 //
PI8006095 // PI8200067

Under the registered pulsFOG trade mark the following trade names of pulsFOG products are used:

pulsFOG BIO

(water cooled thermal fogger with 2 tanks for water and pesticide)

DECOFOG

(Portable thermal fogger with special design for decontamination)

COLFOGGER

(Heavy duty coldfogger mounted on wheels with a flow rate more than 30 l/h)

Turbo ULV

(portable electric coldfogger with 5 l tank)

TracFOG

(Coldfogger with PTO drive)

TURBOMATIC

(Autostationnary electric coldfogger on turntable, computer controlled)

MINIMATIC

(Autostationnary electric coldfogger, computer controlled)

nutriFOG

(Fogging additive with foliar fertilizing properties, bio-active, for the conversion of plant protective chemicals into a fogging formulation in glasshouses)

VK-2 special

(Fog enhancer for water based fogging formulations)



pulsFOG

DR. STAHL & SOHN GMBH

Abigstrasse 8
D-88662 Überlingen
Germany

Tel: +49 7551 92610
Fax: +49 7551 926161
E-mail: info@pulsfog.com

// www.pulsfog.com